

## Product Features

- Compliant with IEEE Std 802.3-2005,100BASE-BX-U
- Compliant with SFF-8074i andSFF-8472, revision 9.5
- Compliant with SFP MSA Specification
- Digital Diagnostic Monitoring available
- Uncooled 1310nm FP Laser
- Up to 155Mb/s bi-directional data links
- Up to 40km on 9/125μm SMF
- Simplex LC connector compliant
- Single +3.3V DC power supply
- Hot-pluggable CSFP footprint
- Class 1 laser safety certified
- Operating temperature Options
  - (Commercial) -10°C to +70°C
  - (Extended) -10°C to +85°C
  - (Industrial) -40°C to +85°C
- RoHS6 Compliant



## Applications

- 100BASE BX IEEE802.3ah
- Point to Point FTTH
- Switched Backplane Applications
- Router/Server Interface
- Switch to Switch Interface
- Other Optical Links

## Descriptions

LX2514xDR CSFP transceivers, according to Compact Small Form Factor Pluggable Multi-Sourcing Agreement (MSA) option 2, The transceiver consists of 2-channel Bi-directional Optical Transceiver unit with five sections: the LD driver, the limiting amplifier, the digital diagnostic monitor, the 1310nm FP laser and the PIN photo-detector .The module data link up to 40KM in 9/125um single mode fiber.

LX2514xDR CSFP transceivers offer a wide range of design options, including Digital Diagnostic Monitoring (DDM) features and three temperature options (commercial, extended or industrial).

LX2514xDR CSFP are compliant with RoHS.

## Ordering Information

**Table 1. Ordering Information**

Part Number	Transmitter	Output Power	Receiver	Sensitivity	Reach	Temp	DDM	RoHS
LX2514CDR	1310nm FP	-5 ~ 0dBm	1490nm PIN	< -31dBm	40km	-10 ~ 70 °C	Available	Compliant
LX2514EDR	1310nm FP	-5 ~ 0dBm	1490nm PIN	< -31dBm	40km	-10 ~ 85 °C	Available	Compliant
LX2514IDR	1310nm FP	-5 ~ 0dBm	1490nm PIN	< -31dBm	40km	-40 ~ 85 °C	Available	Compliant

## Pin Description

**Table 2. Pin Description**

Pin	Name	Function/Description	Notes
1	VEE	Transceiver Ground	VEE may be internally connected within the SFP module
2	TX Fault	Transmitter Fault Indication	TX Fault is an open collector/ drain output, which should be pulled up with a 4.7K–10K resistor on the host board. Note 1 for more information
3	TX1_Disable	Transmitter Disable of Ch A	Module channel A disables function
4	MOD-DEF2	Two-wires interface Data	2 wire serial ID interface, SDA
5	MOD-DEF1	Two-wires interface Clock	2 wire serial ID interface, SCL
6	TD2-	Inverted Transmit Data Input of Ch B	These are the differential transmitter puts. They are AC-coupled, differential lines with 100 differential termination inside the module. The AC coupling is done inside the module and is thus not required on the host board
7	TD2+	Transmit Data Input of Ch B	
8	LOS1	Loss of Signal of Ch A	Loss of Signal detected function. Note 2 for more information.
9	RD2+	Received Data Output of Ch B	These are the differential receiver outputs. They are AC coupled 100 differential lines which should be terminated with 100(differential) at the user SERDES. The AC coupling is done inside the module and is thus not required on the host board.
10	RD2-	Inverted Received Data Output of Ch B	
11	VEE	Transceiver Ground	VEE may be internally connected within the SFP module.
12	RD1-	Inverted Received Data Output of Ch A	These are the differential receiver outputs. They are AC coupled 100 differential lines which should be terminated with 100(differential) at the user SERDES. The AC coupling is done inside the module and is thus not required on the host board.
13	RD1+	Received Data Output of Ch A	
14	LOS2	Loss of Signal of CH B	Loss of Signal detected function. Note 2 for more information.
15	VCCR	Receiver Power	3.3V± 5%. Note 3 for more information
16	VCCT	Transmitter Power	3.3V± 5%. Note 3 for more information
17	TX2_Disable	Transmitter Disable of Ch B	Module channel B disables function
18	TD1+	Transmit Data Input of Ch A	These are the differential transmitter puts. They are AC-coupled, differential lines with 100 differential termination inside the module. The AC coupling is done inside the module and is thus not required on the host board
19	TD1-	Inverted Transmit Data Input of Ch A	
20	VEE	Transceiver Ground	VEE may be internally connected within the SFP module.

**Notes:**

1. When high, output indicates a laser fault of some kind either in Channel A or Channel B. The Host shall read Channel A/B for details: TX Fault from channel A if bit 2 is set in [A2H:110]; TX Fault from channel B if bit 2 is set in [B2H: 110]. Low indicates normal operation. In the low state, the output will be pulled to < 0.8V.
2. When high, this output indicates the received optical power is below the worst-case receiver sensitivity (as defined by the standard in use). Low indicates normal operation. In the low state, the output will be pulled to < 0.4V.
3. VccT VccR are the power supplies. They are defined as 3.3V ±5% at the SFP connector pin. Maximum supply current is 400Ma@3.3V. Vcc may be internally connected within the SFP transceiver module.

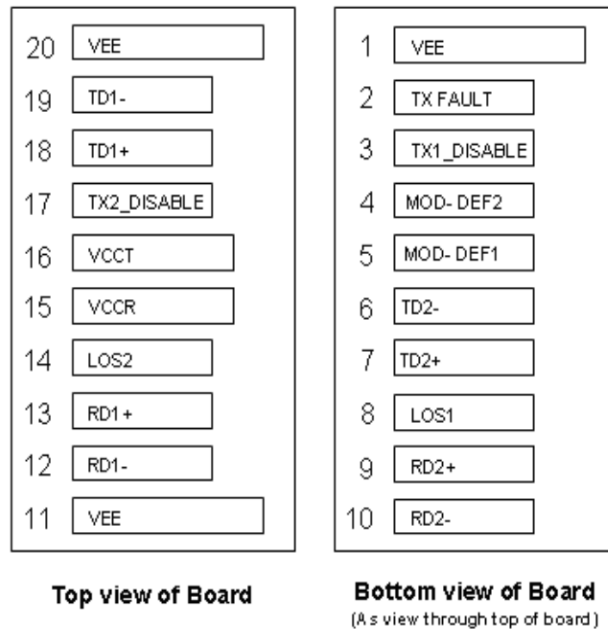
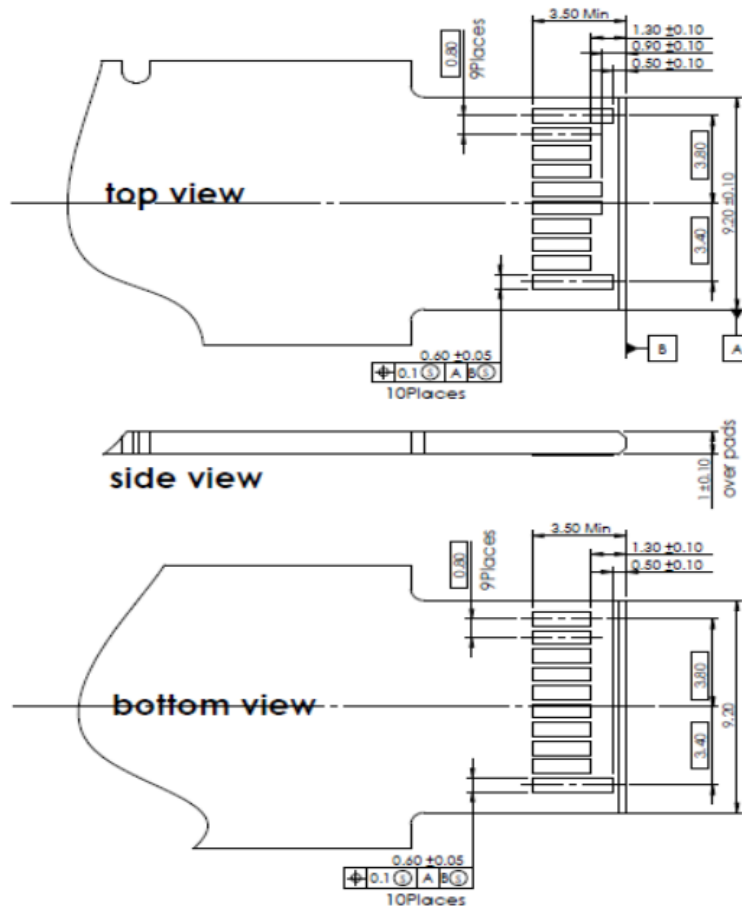

Figure 1. Pin out of Connector Block on Host Board



## Absolute Maximum Ratings

Stresses in excess of the absolute maximum ratings can cause permanent damage to the device. These are absolute stress ratings only. Functional operation of the device is not implied at these or any other conditions in excess of those given in the operational sections of the data sheet. Exposure to absolute maximum ratings for extended periods can adversely affect device reliability.

**Table 3. Absolute Maximum Ratings**

Parameter	Symbol	Minimum	Maximum	Unit
Storage Temperature	T <sub>s</sub>	-40	85	°C
Relative Humidity	RH	5	95	%
Supply Voltage	V <sub>cc</sub>	-0.5	4	V

## Recommended Operating Conditions

**Table 4. Recommended Operating Conditions**

Parameter	Symbol	Min	Typ	Max	Unit	
Operating Case Temperature	LX2514CDR	T <sub>c</sub>	-10	-	70	°C
	LX2514EDR	T <sub>e</sub>	-10		85	°C
	LX2514IDR	T <sub>i</sub>	-40		85	°C
Supply Voltage	V <sub>cc</sub>	3.15	3.3	3.45	V	
Data Rate	-	-	125/125	155/155	Mb/s	

## Transceiver Electrical Characteristics

**Table 5. Transceiver Electrical Characteristics**

Parameter	Symbol	Minimum	Typical	Maximum	Unit	Notes
Module Supply Current	I <sub>cc</sub>	-	-	450	mA	-
Power dissipation	P <sub>D</sub>	-	-	1.5	W	-
Low speed output: Transmitter Fault(TX_FAULT) / Loss of Signal (LOS)	VOH	2.0	-	V <sub>cc</sub> +0.3	V	3
	VOL	0	-	0.8	V	-
Low speed iutput: Transmitter Disable (TX_DISABLE), MOD_DEF 1, MOD_DEF 2	VIH	2.0	-	V <sub>cc</sub> +0.3	V	4
	VIL	0	-	0.8	V	-

**Notes:**

1. Pulled up externally with a 4.7KΩ-10KΩ resistor on the host board to V<sub>CCT,R</sub>.
2. Mod\_Def1 and Mod\_Def2 must be pulled up externally with a 4.7KΩ-10KΩ resistor on the host board to V<sub>CCT,R</sub>.

## Transmitter Optical Characteristics

**Table 6. Transmitter Optical Characteristics**

Parameter	Symbol	Minimum	Typical	Maximum	Unit	Notes
Launch Optical Power	P <sub>o</sub>	-5	-	0	dBm	-
Center Wavelength Range	$\lambda_c$	1260	1310	1360	nm	-
Extinction Ratio	EX	10	-	-	dB	-
Spectral Width (RMS) @1310nm	$\Delta\lambda$	-	-	4	nm	-
P <sub>out</sub> @TX-Disable Asserted	P <sub>off</sub>	-	-	-45	dBm	-
Eye Diagram	Compliant with IEEE802.3 ah (class 1 laser safety)					

## Receiver Optical Characteristics

**Table 7. Receiver Optical Characteristics**

Parameter	Symbol	Minimum	Typical	Maximum	Unit	Notes
Wavelength Range	-	1470	1490	1600	nm	-
Receiver Sensitivity	S	-	-	-31	dBm	1
Receiver Overload	P <sub>OL</sub>	-10	-	-	dBm	1
Optical Return Loss	ORL	12	-	-	dB	-
LOS De-Assert	LOS <sub>D</sub>	-	-	-32	dBm	1
LOS Assert	LOS <sub>A</sub>	-45	-	-	dBm	-
LOS Hysteresis	-	0.5	2	5	dB	-

**Notes:**

1. Measured with PRBS 2<sup>23</sup>-1 test pattern, 155Mb/s, EX=10dB, BER<10<sup>-12</sup>.

## Digital Diagnostic Memory Map

### Channel 1:

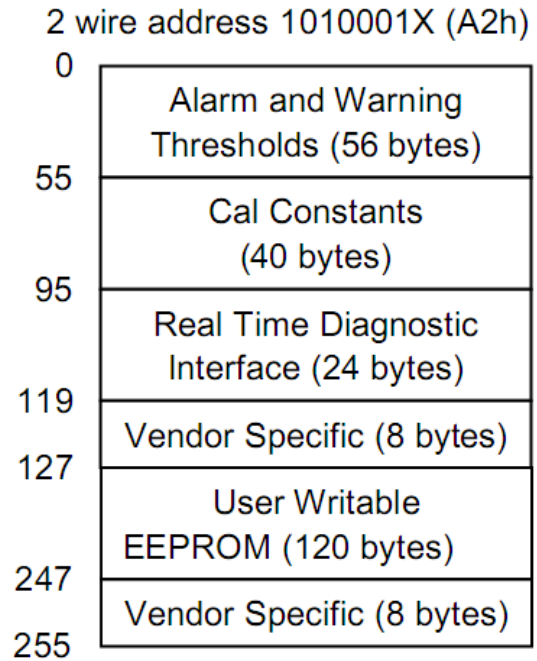
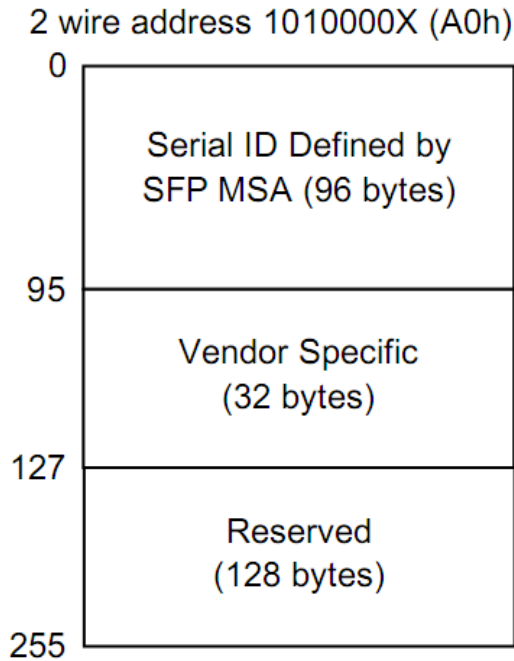

### Channel 2:

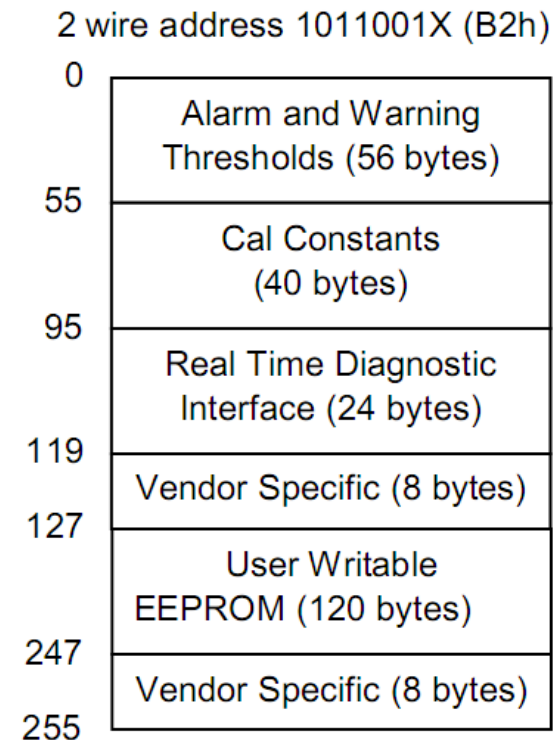
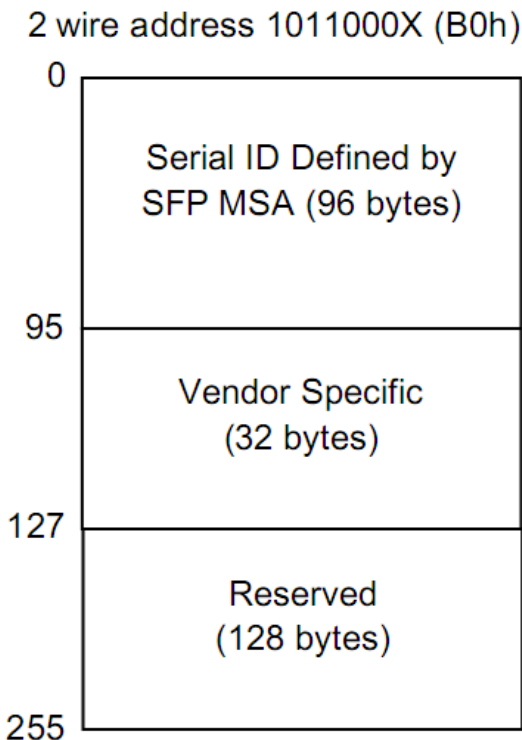

Figure 2. Digital Diagnostic Memory Map Specific Data Field Descriptions

## EEPROM Serial ID Memory Contents

The CSFP MSA defines a 256-byte memory map in E2PROM that is accessible over a 2-wire serial interface at the 8 bit address 1010000X (A0h) or 1011000X(B0h). The digital diagnostic monitoring interface makes use of the 8 bit address 1010001X (A2h) or 1011001X(B2h), so the originally defined serial ID memory map remains unchanged.

**Table 8. Data Fields for 2ch Compact SFP**

Data Address	Name of Field	Contents(Hex)	Description
0	Identifier	03	SFP
1	Ext. Identifier	04	SFP function is defined by serial ID
2	Connector	07	LC
3-10	Transceiver	00 00 00 40 12 00 01 01	100BASE-BX-U
11	Encoding	03	NRZ
12	BR, Nominal	02	155Mb/s
13	Reserved	00	-
14	Length (9µm) km	28	40km
15	Length (9µm) 100m	FF	40000m
16	Length (50µm) 10m	00	-
17	Length(62.5µm)10m	00	-
18	Length (Copper)	00	-
19	Reserved	00	-
20-35	Vendor name	4C 49 4E 4B 54 45 4C 20 20 20 20 2020 20 20 20	“LINKTEL”(ASCII)
36	Reserved	00	-
37-39	Vendor OUI	00 00 00	-
40-55	Vendor PN	4C 58 32 35 31 34 xx 44 52 20 20 20 20 20 20 20	“LX2514xDR ” (ASCII)
56-59	Vendor rev	31 2E 30 00	Rev 1.0 ( ASCII)
60-61	Wavelength	05 1E	1310nm
62	Reserved	00	-
63	CC BASE	xx	Check sum of bytes 0 - 62
64-65	Options	00 12	LOS, TX_DISABLE
66	BR, max	00	-
67	BR, min	00	-
68-81	Vendor SN	31 34 30 30 30 38 32 32 20 20 20 20 20 20	Serial Number of transceiver (ASCII). For example “14000822”.
82		2D	2Dh, ASCII code of “-”
83		32	Channel number in ASCII code(31h for ch1 and 32h for ch2)

84-91	Vendor date code	xx xx xx xx xx 20 20	Year (2 bytes), Month (2 bytes), Day (2 bytes)
92	Diagnostic type	68	Diagnostics (Internally Cal)
93	Enhanced option	90	Diagnostics(Optional Alarm/warning flags, Soft TX_LOS monitoring)
94	SFF-8472	02	Diagnostics(SFF-8472 Rev 9.5)
95	CC_EXT	xx	Check sum for bytes 64-94
96-255		00	

**Note:** The “xx” byte should be filled in according to practical case. For more information, please refer to the related document of SFF-8472 Rev 9.3.

## Diagnostic Monitor Specifications

The operating and diagnostics information is monitored and reported by a Digital Diagnostics Transceiver Controller (DDTC) inside the transceiver, which is accessed through a 2-wire serial interface. When the serial protocol is activated, the serial clock signal (SCL, Mod Def 1) is generated by the host. The positive edge clocks data into the SFP transceiver into those segments of the E2PROM that are not write-protected. The negative edge clocks data from the SFP transceiver. The serial data signal (SDA, Mod Def 2) is bi-directional for serial data transfer. The host uses SDA in conjunction with SCL to mark the start and end of serial protocol activation. The memories are organized as a series of 8-bit data words that can be addressed individually or sequentially.

**Table 9. Diagnostic Monitor Specifications**

	Parameter	Range	Accuracy	Calibration
Temperature	LX2514CDR	-15 to +80°C	±3°C	Internal
	LX2514EDR	-15 to +95°C	±3°C	Internal
	LX2514IDR	-40 to +95°C	±3°C	Internal
Voltage		2.9 to 3.6V	±3%	Internal
Bias Current		0 to 80mA	±10%	Internal
TX Power		-6 to +1dBm	±3dB	Internal
RX Power		-32 to -9dBm	±3dB	Internal

**Recommended Application**

**Interface Circuit**



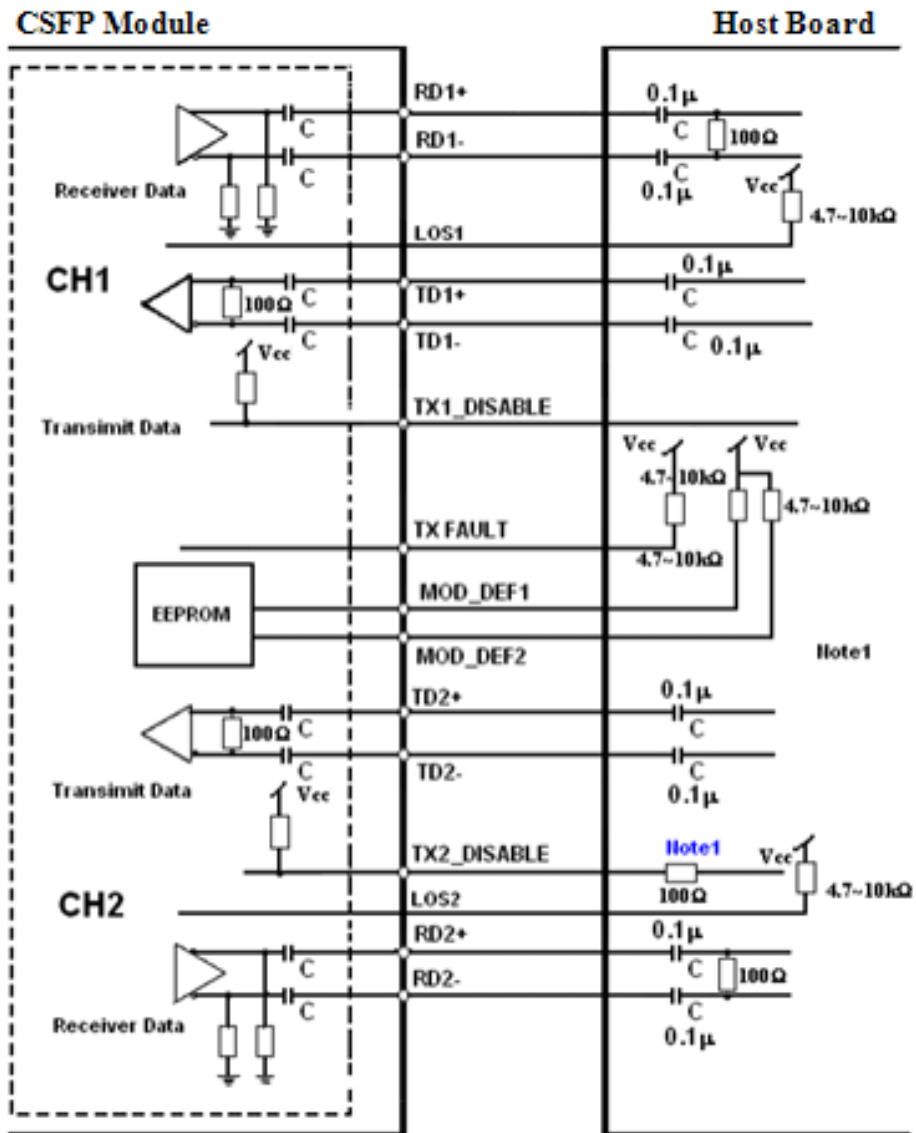

Figure 3. Recommended Application Interface Circuit

**Note1:** Recommendation 100Ω series resistance on host board.

## Mechanical specifications

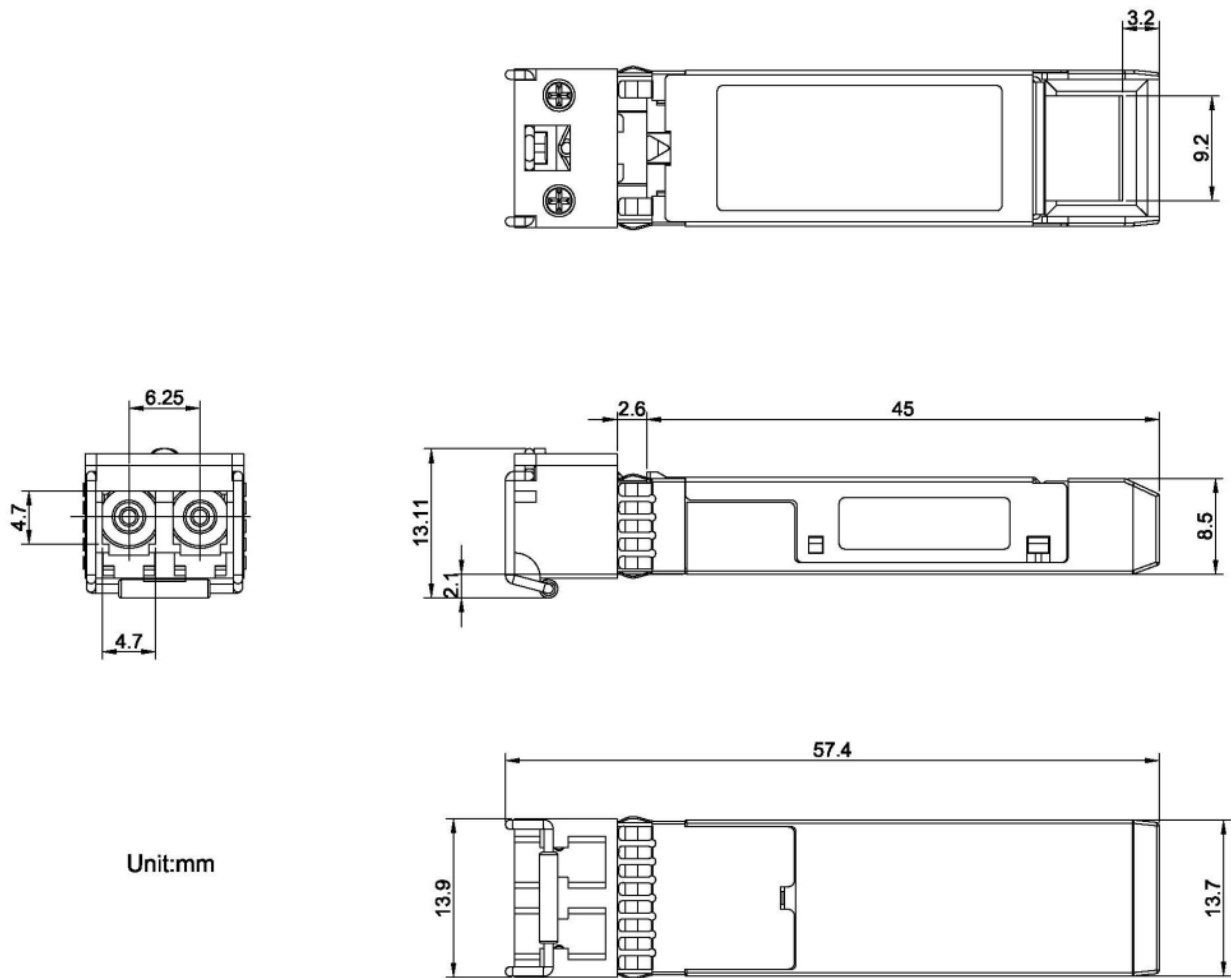

Figure 5. Outline Drawing

## **For More Information**

### **Linktel Technologies Co., Ltd**

sales@linkteltech.com

<http://www.linkteltech.com>

### **Linktel China**

No 20 University Science Park Road

East Lake Hi-tech Development Zone, Wuhan, 430223, China

Tel: +86 27-87929302

### **Linktel USA**

3391 Ingersoll Ct., San Jose, CA 95148

Tel: +1-408-2613988